

PDF technical sheet 22317EMW33C3



Double row spherical roller bearings

Spherical roller bearing, one-piece machined cage, groove and lubrication holes on outer ring

Product definition	
d	3.3465 "
D	7.0866 "
B	2.3622 "
d2	4.2480 "
D1	6.1693 "
rs min	0.1181 "
Number of lubrication holes	3
b	0.4331 "
k	0.1969 "
e	0.32
Y1	2.09
Y2	3.11
Y0	2.04
Radial clearance class	C3
Mass	25.26 oz
Brand	SNR

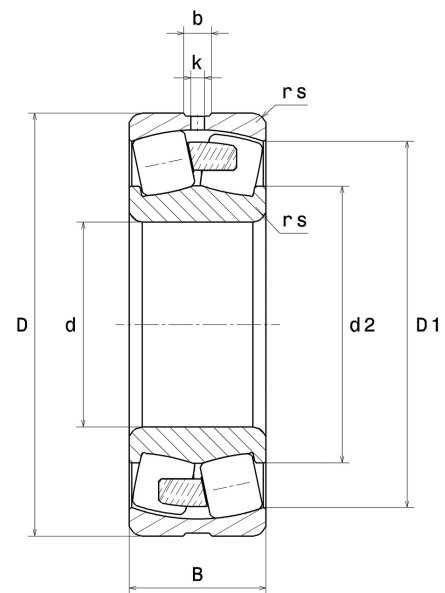

Product performance	
Dynamic load, C	599 kN
Static load, C0	604 kN
Fatigue limit load, Cu	52.60 kN
Nref	3,200 RPM
Nlim	3,600 RPM
Min operating temperature, Tmin	-40 °C
Max operating temperature, Tmax	392 °C
Characteristic cage frequency, FTF	0.41 Hz
Characteristic rolling element frequency, BSF	5.10 Hz
Characteristic outer ring frequency, BPF0	6.11 Hz
Characteristic inner ring frequency, BPF1	8.89 Hz

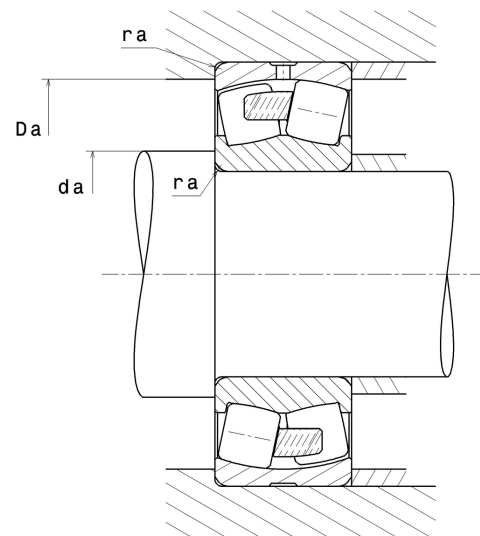

Abutment dimensions

da min	3.8976 "
Da max	6.5354 "
ra max	0.0984 "

Calculation factors

Equivalent dynamic radial load

$$P = X.F_r + Y.F_a$$

Fa / Fr ≤ e		Fa / Fr > e	
X	Y	X	Y
1	Y1	0.67	Y2

Equivalent static radial load

$$P_0 = X_0.F_r + Y_0.F_a$$

X ₀	Y ₀
1	Y0

The values for e, Y1, Y2 and Y0 are shown in the above table .