

Karta techniczna PDF EXP206L4COE

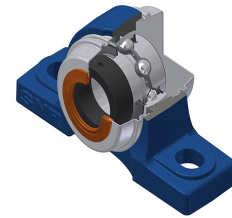

Zespoły łożyskowe

Dane techniczne	
A	48 mm
A1	30 mm
B	36,40 mm
B1	48,30 mm
d	30 mm
d1	44,10 mm
Dz	70 mm
G	M6x1
H	42,90 mm
H1	18 mm
H2	83 mm
J	121 mm
L	165 mm
L1	54 mm
N	17 mm
N1	21 mm
s1	34,10 mm
S	18,20 mm
Z	71,20 mm

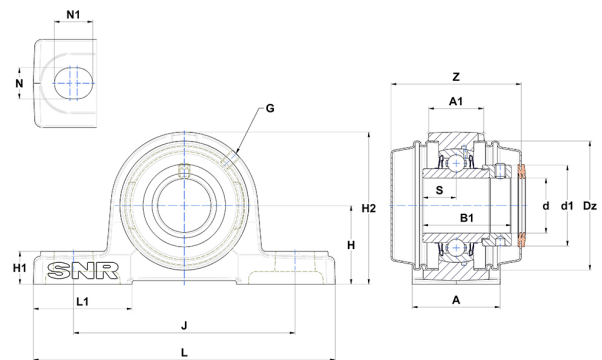

Parametry	
C	19,50 kN
C0	11,20 kN
T min.	-20 °C
T max.	100 °C

Inne dane	
Waga	1,46 kg
Zalecane momenty dokręcania dla zestawu śrub	5,50 Nm
Oznaczenie oprawy	P206N
Oznaczenie łożyska	EX206G2L4
Oznaczenie otwartej pokrywy	SCOE20630