

## Karta techniczna PDF UCPE20618NT20

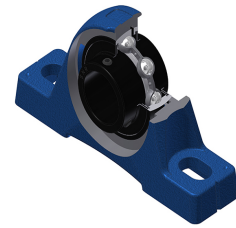

### Zespoły łożyskowe

Dane techniczne	
A	40 mm
A1	25 mm
B	38,10 mm
d	28,58 mm
G	R1/8"
H	42,90 mm
H1	17 mm
H2	82 mm
J	118 mm
L	158 mm
L1	47 mm
N	14 mm
N1	22 mm
s1	19,05 mm
S	15,90 mm
Z	18,50 mm

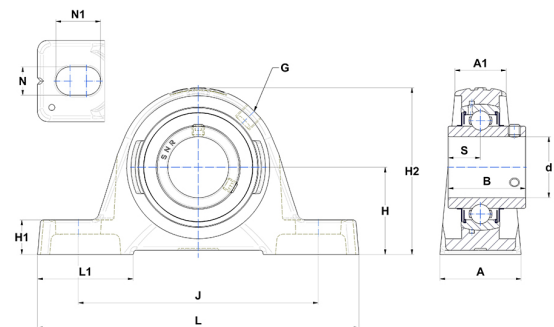

Parametry	
C	19,50 kN
C0	11,20 kN
T min.	-20 °C
T max.	200 °C

Inne dane	
Waga	1,14 kg
Zalecane momenty dokręcania dla zestawu śrub	3,70 Nm
Oznaczenie oprawy	PE206N
Oznaczenie łożyska	UC20618G2T20