

Karta techniczna PDF UKP206HN

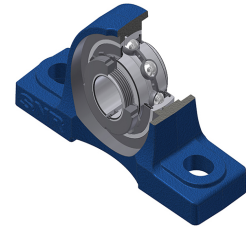

Zespoły łożyskowe

Dane techniczne

A	48 mm
A1	30 mm
B	25 mm
B1	38 mm
d	25 mm
d1	45 mm
G	M6x1
H	42,90 mm
H1	18 mm
H2	83 mm
J	121 mm
L	165 mm
L1	54 mm
N	17 mm
N1	21 mm
s1	20,50 mm
Z	19,20 mm

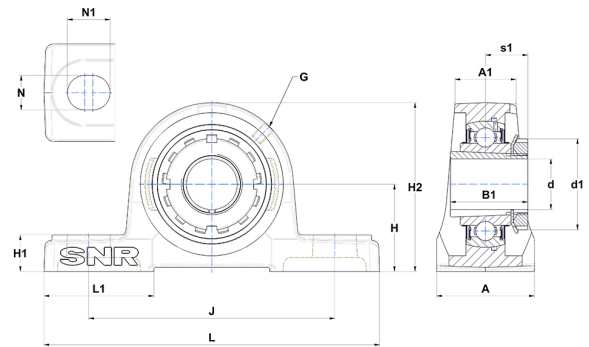

Parametry

C	19,50 kN
C0	11,20 kN
T min.	-20 °C
T max.	100 °C

Inne dane

Waga	1,38 kg
oznaczenie tulei wciąganej	H2306
Oznaczenie oprawy	P206N
Oznaczenie łożyska	UK206G2H