

Karta techniczna PDF UKP20924H

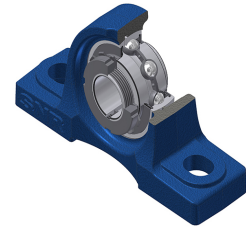

Zespoły łożyskowe

Dane techniczne

A	54 mm
A1	37 mm
B	30 mm
B1	50 mm
d	38,10 mm
d1	65 mm
G	M6x1
H	54 mm
H1	20 mm
H2	108 mm
J	146 mm
L	190 mm
L1	60 mm
N	17 mm
N1	23 mm
s1	26 mm

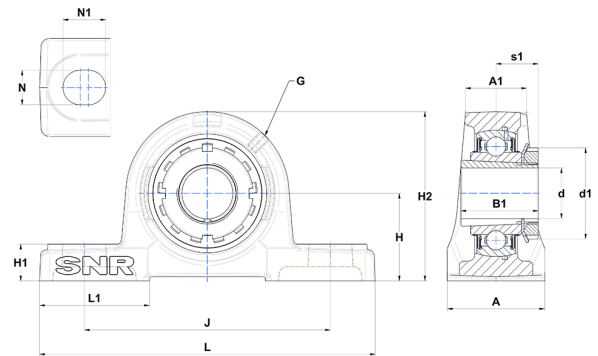

Parametry

C	31,85 kN
C0	20,80 kN
T min.	-20 °C
T max.	100 °C

Inne dane

Waga	2,54 kg
oznaczenie tulei wciąganej	H230924
Oznaczenie oprawy	P209
Oznaczenie łożyska	UK209G2H24